

provided my 2.3.-3kW (modified) Madusa petrol generator as backup. I also used a small 500W Honda, just for my station, if there was no big geny running during some parts of the day.

As you can see with such a busy site some RF operating order has to be imposed, & it is done by being in possession of the "club logbook for that band", giving you permission to operate on it.

G8MNY VAN & TENT LAYOUT

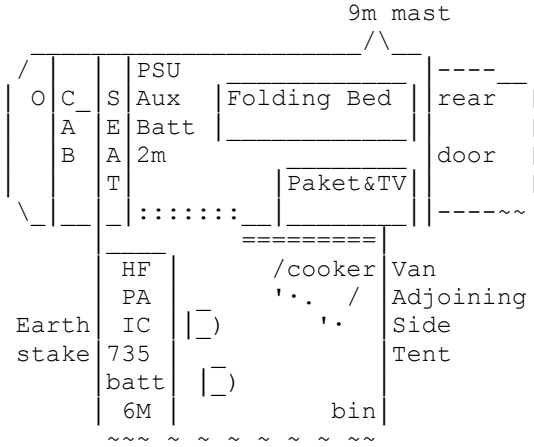

HF & 6M OPERATING TABLE LAYOUT

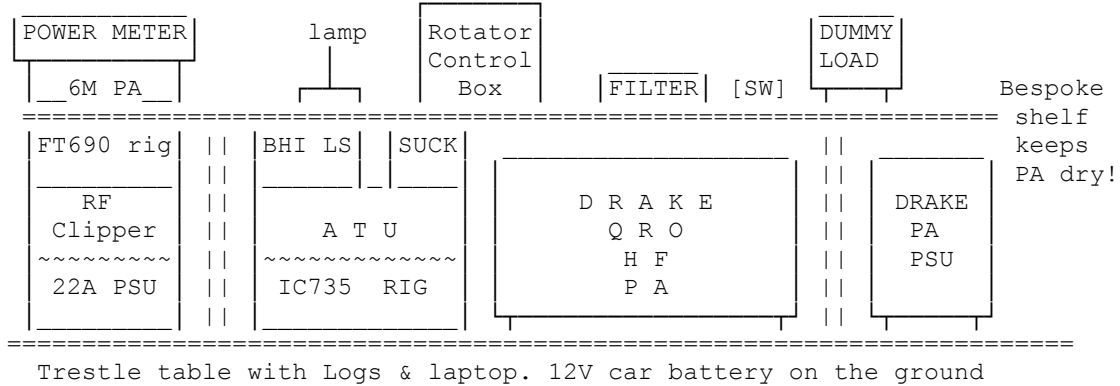

Kit By Band
144MHz FM Talk in

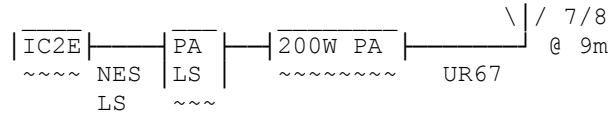

144MHz Packet (Very QRP @ 1mW)

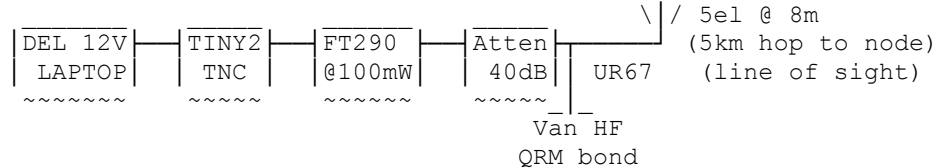

50MHz SSB Phone

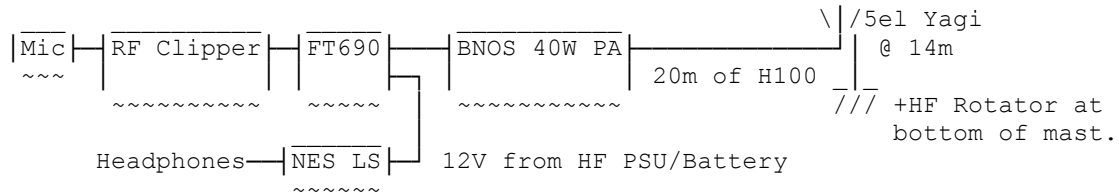

HF SSB/PSK31

ptt+ALC QRO available only when large geny is running.

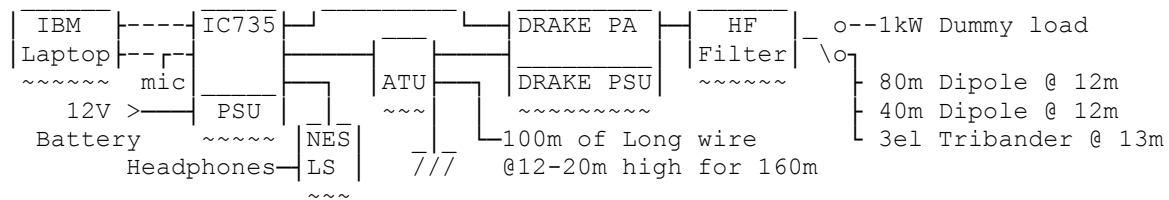

DOMESTIC COMFORTS powered from the 110AH Aux battery & 40A SMPSU/8A Honda DC. TV

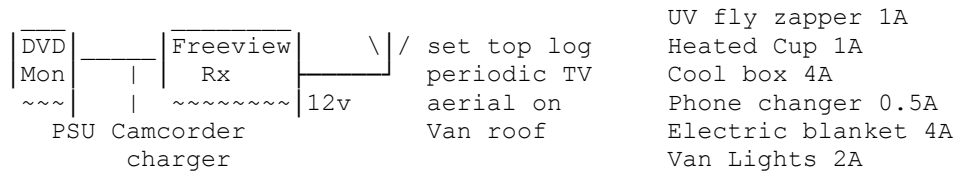

Why Don't U send an interesting bul?

73 de John G8MNY @ GB7CIP